

Data Sheet



Article number: 2030120M30125A1U

Description: E+G levelling foot
GN 30-120-M30-125-A1-U

Note: U Without nut, Hexagon socket at the top, Wrench flat at the bottom

Measures

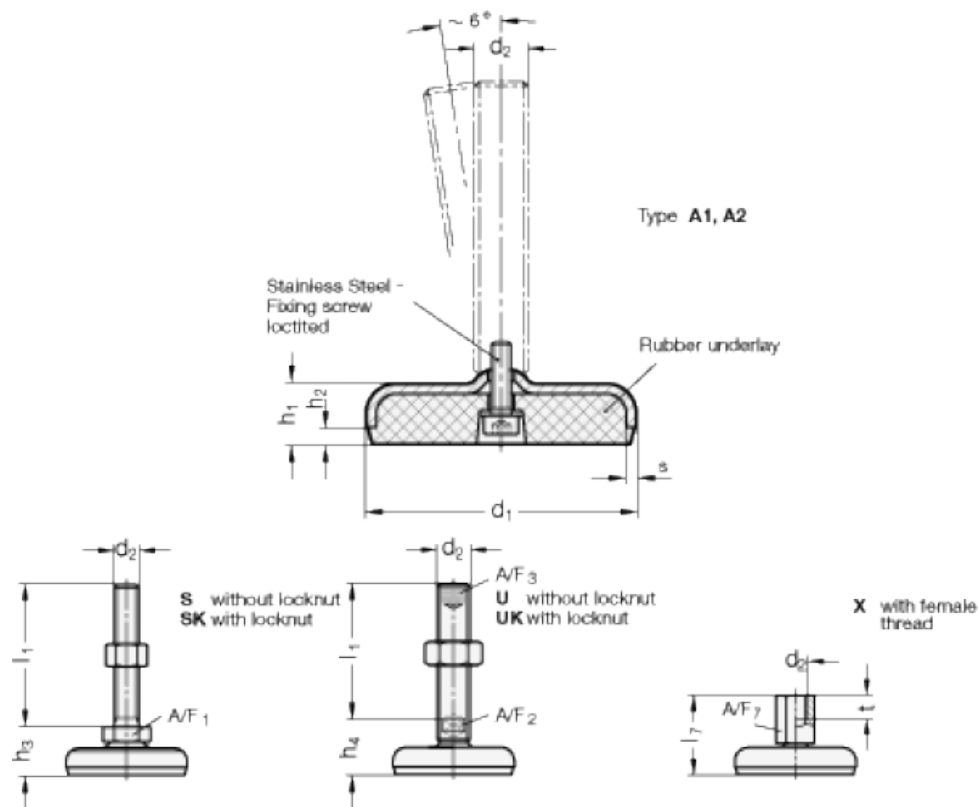

A/F2 = 24
A/F3 = 12
d1 = 120
d2 = M30
h1 = 22
h2 = 6
h4 = 46
l1 = 125

s = 4